



# Standard Beta Vehicle Manual

## Contents

Welcome .....	1
How to contact us .....	2
Breakdowns .....	3
Mechanical Faults .....	3
Accidents.....	3
Emergencies .....	3
Toll Roads.....	4
Spaceships Depot Information .....	6
<b>Space Mates Discounts .....</b>	<b>7</b>
Camping in Australia.....	9
Spaceships Camping App .....	9
Vehicle Information .....	11
Checking Oil Level.....	13
Checking Coolant.....	13
Tyres .....	14
Operating your Spaceship .....	15
Warning Lights .....	16
How to jump start a Spaceship.....	17
<b>Bed Set Up.....</b>	<b>18</b>
Internal Set Up .....	18
How to Extend the Bed Internally .....	18
For extending the bed at the rear: .....	18
How to Put up the Back Awning .....	19
How to Use the Cooker.....	20
Understanding the Electrical System .....	21
<b>Essential Road Trip Apps .....</b>	<b>22</b>

## Welcome

Welcome to your journey to Outer Space!

We hope you have an amazing adventure through Australia in your Spaceship.

This manual is designed to help you get the most out of your vehicle. With information on how the vehicle works and other bits of information that will help on your journey.

**Don't forget to share your journey with us:**

**#spaceshipsroadtrip**



## How to contact us!

The most important number for you to know is our number. Please call us if there are any issues you are having with the van or if you are unsure how anything works. We are here to help!

**Spaceships Ground Control: 1300 132 469 Option 1**

### Contact Hours:

7 days a week, 9:30 AM – 5:30 PM EST (NSW/VIC time zone)

### Extended Summer hours:

Mon-Fri 9:00 AM – 6:00 PM AEDT (NSW/VIC time zone; 8:00 AM - 5:00 PM QLD time)

Sat-Sun 9:30 AM – 5:30 PM

If easier you can contact us through our online [Live Chat](#) found on our website.

Or Email: [enquiries@spaceshipsrentals.com.au](mailto:enquiries@spaceshipsrentals.com.au)



## Breakdowns

In the unlikely event of a breakdown please call us immediately:

### **Call Spaceships 1300 132 469 Option 3**

This will come through to our service team who will be able to advise what to do. If necessary, we will put you through to our Roadside Assistance service – RACQ.

Outside of office hours the phone line will go straight through to RACQ who will be able to assist.

Make sure you have your vehicle Registration and exact location and the vehicle is stopped in a safe location.

**Charges may apply for Non-Mechanical Callouts from RACQ.**

## Mechanical Faults

Report all other mechanical faults straight to Spaceships. Call us on 1300 132 469 and we can arrange for repairs to be done.

## Accidents

If you and your Spaceship are involved in an accident there are some basic things that will help you:

- Try to stay calm and stop straight away. Help anyone who is injured. Call an ambulance on 000, if it is needed.
- Give your name and address to the driver of any car that's been damaged and to the owner of any property that's been damaged.
- If other drivers are involved, try to find out whether they are insured and who they are insured with. If other drivers are at fault you must get details of the other driver or you may be liable for damages.
- Fill out the accident report form immediately.
- If you can't drive your Spaceship after the accident, protect it to prevent any more loss or damage, such as taking it to the side of the road and locking it. Take your personal possessions with you.
- Notify Police as soon as possible – within 24 hours as required by law.

**You must contact Spaceships immediately to report an accident – 1300 132 469**

## Emergencies

Fire – Police – Ambulance Dial 000



## Toll Roads

Please take care to ensure that you understand how the Toll Roads work here in Australia. If you are travelling to Brisbane, Sydney or Melbourne you are likely to take some toll roads where you need to pay to travel on that road.





In Australia toll roads are electronically tolled, which means there is no stopping and you can't pay cash, instead you will need to register and pay online.

Please note that failure to do so will incur a \$30 admin charge which will be taken from your credit card for each toll notice handled. You will remain liable for the payment of the toll.

Tolls must be paid within 72 hours of travelling over the toll road – after this time an unpaid notice will be sent to Spaceships and you will incur the \$30 admin fee.

**Toll roads include, but are not limited to the following:**



City	Toll Roads	Pass Provider	To register
<b>Sydney</b> (NSW)	Hills M2, WestConnex, M5 South-West Motorway, Westlink M7, Eastern Distributor, Cross City Tunnel, Lane Cove Tunnel, Sydney Harbour Bridge & Tunnel	 	<p>The eMU PASS covers travel on all Sydney toll roads for up to 30 days</p> <p><a href="https://www.myrta.com/wps/portal/extvp/myrta/etoll/product-pass">https://www.myrta.com/wps/portal/extvp/myrta/etoll/product-pass</a></p> <p>Or call: 13 18 65</p> <p>*Request a PASS and not an E-Tag or account.</p>
<b>Brisbane</b> (QLD)	Gateway Motorway Logan Motorway Clem7 Go Between Bridge Legacy Way Airportlink M7	 	<p>The Linkt Brisbane Road PASS covers travel on all Brisbane toll roads for up to 30 days. Register online via;</p> <p><a href="https://www.linkt.com.au/brisbane/pay-for-tolls.html">https://www.linkt.com.au/brisbane/pay-for-tolls.html</a></p> <p>Or call: 13 33 31</p> <p>*Request a PASS and not an E-Tag or account.</p>

<p><b>Melbourne</b> (VIC)</p>	<p>CityLink and Eastlink tollways</p>	<p style="text-align: center;"><b>Linkt</b></p> 	<p>The Linkt Melbourne Road PASS covers travel on Citylink &amp; Eastlink toll roads for up to 30 days</p> <p><a href="https://manage.linkt.com.au/retailweb/openaccount/melbournepass/melbourne">https://manage.linkt.com.au/retailweb/openaccount/melbournepass/melbourne</a></p> <p>Or call: 13 33 31</p> <p>*Request a PASS and not an E-Tag or account.</p>
-----------------------------------	---------------------------------------	---	--

### Extra Toll Road Tips:

Take care when registering for your pass that details are correct, as an error will result in infringements being issued and associated fees applied. Some tips to help avoid errors;

- Check that the pass you are purchasing covers travel on the toll road that you have used. For example, the Linkt Brisbane Road pass covers toll road usage in Brisbane, but not Sydney.
- You must register for a pass within 3 days of driving on the toll road. Your pass start date should be the date that you drove through your first toll point. Selecting a start date on the calendar which is more than 3 days earlier will cause an error.
- The pass start and end date and time should adequately cover the period in which you travel on toll roads.
- Funds must be available on the credit card that you have registered
- Note that your toll road usage is not immediately visible in the system of the toll operator/pass provider. If you have driven on a toll road, it is essential that you register for a pass.

**Note:** For renters using Electronic Tags in their private vehicles, the tag provider does NOT recommend that these be transferred and used in your rental vehicle. Renters should register their toll travel via a PASS, as per the information above.

## Spaceships Depot Information



**Cairns Address:** 397 Sheridan St, Cairns North, QLD 4870

Click here for: [Directions](#)

**Opening hours:**

Mon-Fri: 10:00am - 4:00pm

Sat 9:00am – 1:00pm

Sun: Closed (After Hours Return Available)

**Closest Car Wash Bay:** **McSuds** 47 Mulgrave Rd, Cairns

**Closest Fuel Station:** **Mobil** 333 Sheridan St, Cairns

**Brisbane Address:** 31 Bunya Street, Eagle Farm QLD 4009

Click here for: [Directions](#)

**Opening hours:**

Mon-Fri: 10:00am - 4:00pm

Sat 9:00am – 1:00pm

Sun: Closed (After Hours Return Available)

**Closest Car Wash:** **Gateway Express** 1097 Nudgee Road, Banyo

**Closest Fuel Station:** **Caltex** 645 Kingsford Smith Drive, Eagle Farm

**Sydney Address:** 1/1545 Botany Rd, Botany NSW 2019

Click here for: [Directions](#)

**Opening hours:**

Mon-Fri: 10:00am - 4:00pm

Sat 9:00am – 1:00pm

Sun: Closed (After Hours Return Available)

**Closest Car Wash Bay:** **IMO Car Wash** 15 Ross Smith Avenue, Mascot

**Closest Fuel Station:** **BP** 1579 Botany Road, Botany

**Melbourne Address:** 42 Macaulay Street, Williamstown North, VIC 3016

Click here for: [Directions](#)

**Opening hours:**

Mon-Fri: 10:00am - 3:00pm

Sat 9:00am – 12:00pm

Sun: Closed (After Hours Return Available)

**Closest Car Wash Bay:** **Grime Stoppers** 304 Kororoit Creek Rd, Williamstown

**Closest Fuel Station:** **7-Eleven** Corner of Kororoit Creek and Millers Roads





# SPACE MATES

FIND YOUR CLOSEST SPACE MATES LOCATION

EACH ACCOMMODATION AND ACTIVITY PLACE LISTED IS A SPACE MATE LOCATION AND OFFERS OBLIGATION FREE LOCAL ADVICE AND SPECIAL DEALS!

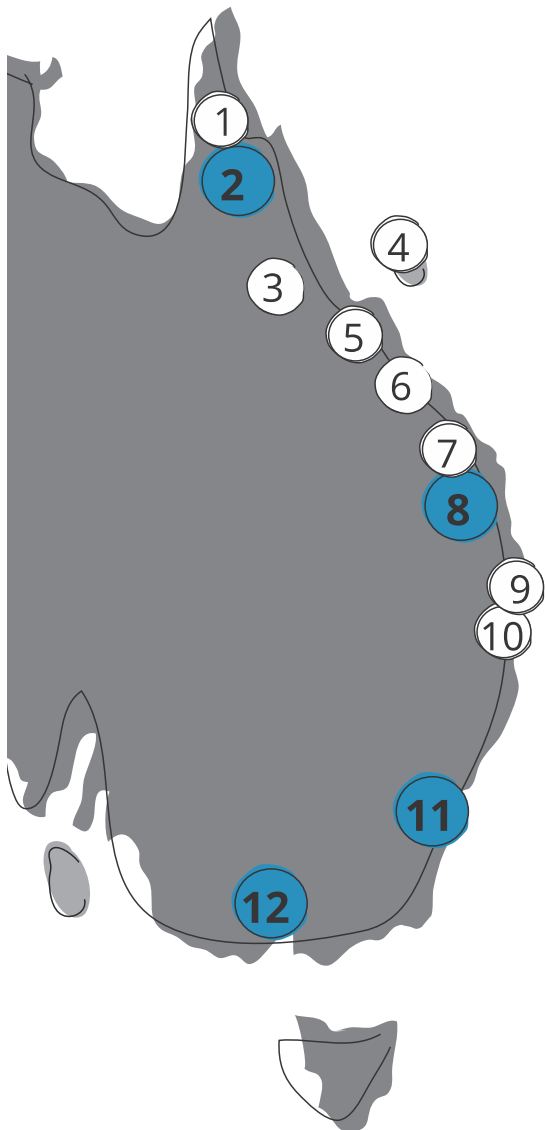

## 1. CAPE TRIBULATION | **PK's Jungle Village**

a: Cape Tribulation Rd, QLD, 4873 p: 07 4098 0040  
\$10 per person per night camping

### CAPE TRIBULATION | **Safari Lodge**

a: Cape Tribulation Rd, QLD, 4873 p: 07 4098 0006  
Located in the HEART of Cape Trip offering powered/unpowered sites, cabins, camp kitchen, laundry and a swimming pool [www.safarilodge.com.au](http://www.safarilodge.com.au)  
Quote "Spaceships" and receive 20% off sites - Direct bookings only

### CAPE TRIBULATION | **Ocean Safari**

a: Cape Tribulation Rd, QLD, 4873 p: 07 4098 0006  
Turtle Tripper Adventure - Half day tour to The Reef from Cape Tribulation  
Quote "Spaceships" and receive free wetsuit/stinger hire - Direct bookings only

## 2. CAIRNS DEPOT |

a: 397 Sheridan St, North Cairns Cairns, QLD p: 1300 132 469

### CAIRNS | **AJ Hackett Bungy**

a: McGregor Rd, Smithfield, QLD, 4878 p: 1800 622 888  
Adult at Student prices! Bungy @ \$139 save \$40  
Swing @ \$99 per day save \$30 / Combo @ \$209 save \$60

### CAIRNS | **Cairns Holiday Park**

a: 12-30 Little St, Cairns, QLD, 4870 p: 1800 259 977  
10% off camping

## 3. YUNGABURRA | **On The Wallaby**

a: 34 Eacham Rd, Yungaburra, Atherton Tablelands, QLD p: 1800 123 311  
\$10 per person per night camping

## 4. MAGNETIC ISLAND | **Base Backpackers**

a: 1 Nelly Bay Road, Magnetic Island, QLD p: 07 4778 5777  
Van Deal: No free parking or staying in van allowed at this property  
Accom Deal: 20% off your stay when booked direct on [www.stayatbase.com](http://www.stayatbase.com)  
Promo code: Spacemate  
Ferry deal: Return Ferry for \$209 bookable via  
email [magnetic@stayatbase.com](mailto:magnetic@stayatbase.com) or phone

### MAGNETIC ISLAND | **Bungalow Bay Koala Village**

a: 42 Horseshoe Bay Rd Magnetic Island, QLD p: 07 4778 5577  
Return Vehicle Ferry + 1 night unpowered camping for 2 only \$200

## 5. AIRLIE BEACH | **Base & Nomads Backpackers**

a: 336 Shute Harbour Road, Airlie Beach, QLD p: 07 4948 2000  
Van Deal: Stay in your van for \$20 per van - only \$10 for 1 pax  
Accom Deal: 20% off your stay when booked direct on [www.stayatbase.com](http://www.stayatbase.com)  
or [www.nomadsworld.com](http://www.nomadsworld.com) Promo code: Spacemate + Free Parking

## 5. AIRLIE BEACH | **Ocean Rafting**

a: Shute Harbour Road, Airlie Beach, QLD p: 07 4946 6848  
Award winning - Ultimate Access to Whitehaven Beaches, Hill Inlet Lookout and Beach and Top Snorkel Spots [www.oceanrafting.com.au](http://www.oceanrafting.com.au)  
Quote "Spaceships" for free wetsuit/stinger hire - Direct bookings only

## 6. EMU PARK | **Emu Park Beach Resort**

a: 92 Pattison St, Emu Park, QLD, 4710 p: 1800 333 349  
Camping \$10 per person + free cocktail voucher

### GREAT KEPPEL ISLAND | **Emu Park Beach Resort**

a: 92 Pattison St, Emu Park, QLD, 4710 p: 07 4939 6111  
2 Nights camping at Emu Park Resort, Return transfer to Ferry  
Day trip to Great Keppel Island including ferry tickets \$75

## 7. NOOSA HEADS | **Noosa Flashpackers**

a: 102 Pacific Ave, Sunshine Beach, QLD p: 07 5455 4088  
10% off all accommodation options if booked direct - Just quote "Spaceships"  
Includes free surfboard hire, free body boards, free wifi, free breakfast



**10% DISCOUNT AT  
AUSTRALIA'S BIGGEST NETWORK OF PARKS**





# SPACE MATES

## FIND YOUR CLOSEST SPACE MATES LOCATION

EACH ACCOMMODATION AND ACTIVITY PLACE LISTED IS A SPACE MATE LOCATION AND OFFERS OBLIGATION FREE LOCAL ADVICE AND SPECIAL DEALS!

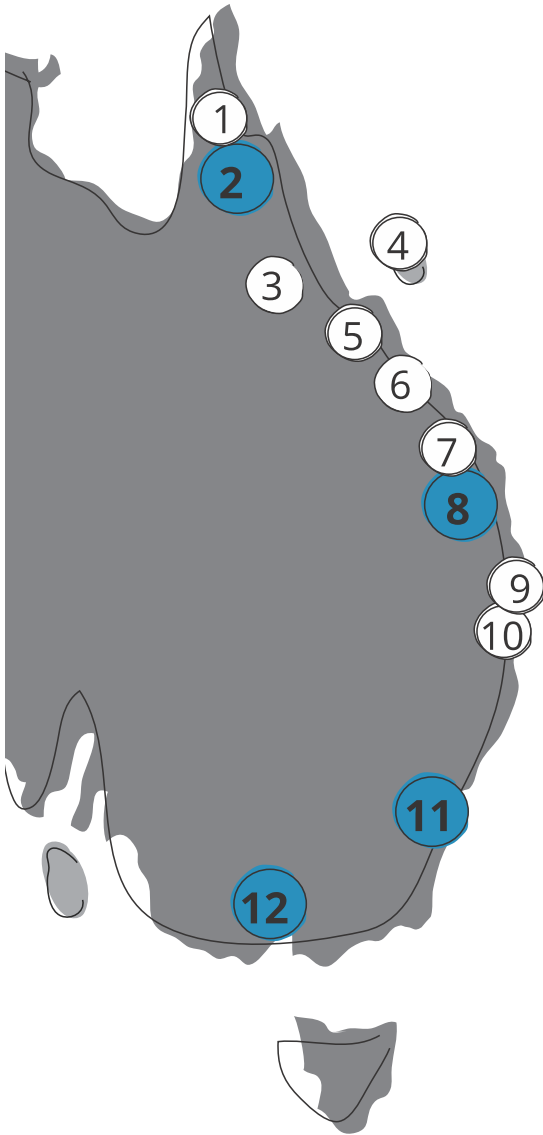

### NOOSA | Habitat Noosa Everglades Eco Camp

a: 204 Lake Flat Rd, Elanda Point, QLD p: 07 5485 3165  
Pristine National Park surrounded by Kangaroos - amazing water views  
Onsite Restaurant and micro-brewery [www.habitatnoosa.com.au](http://www.habitatnoosa.com.au)  
Discounted \$15 per person per night + discounted Noosa Everglade tours

### NOOSA | Nomads

a: 44 Noosa Drive, Noosa Heads, QLD p: 1800 666 237  
Van Deal: Staying in the van is not allowed at this property  
Accom Deal: 20% off your stay when booked direct on  
[www.nomadsworld.com](http://www.nomadsworld.com) Promo code: Spacemate + Free Parking

### 7. SUNSHINE COAST | Rivershore Resort

a: 99 David Low Way Drive, Maroochydore QLD p: 07 5458 2200  
20% off campsites + free welcome drink

### 8. BRISBANE DEPOT |

a: 31 Buyna St, Eagle Farm, Brisbane, QLD p: 1300 132 469

### BRISBANE | Nomads Brisbane

a: Cnr Edward and Ann St, Brisbane, QLD, 4000 p:  
Van Deal: No free parking or staying in van allowed at this property  
Accom Deal: 20% off your stay when booked direct on  
[www.nomadsworld.com](http://www.nomadsworld.com) Promo code: Spacemate

### 9. BYRON BAY | Nomads Byron Bay

a: 1 Lateen Ln, Byron Bay, NSW p: (02) 6680 7966  
Van Deal: Staying in van not allowed at this property  
Accom Deal: 20% off your stay when booked direct on [www.nomadsworld.com](http://www.nomadsworld.com)  
Promo code: Spacemate + Free Underground Parking (usually \$10 per night)

### BYRON BAY | Nomads Arts Factory

a: 1 Skinners Shoot Rd, Byron Bay, NSW p: (02) 6685 7709  
Van Deal: Stay in your van for \$20 per van - only \$10 for 1 pax  
Accom Deal: 20% off your stay when booked direct on  
[www.nomadsworld.com](http://www.nomadsworld.com) Promo code: Spacemate + Free Parking  
Both deals include free activities and workshops. Make diggeridoo, meditate  
in tranquil surrounds and enjoy morning yoga sessions

### 10. ARRAWARRA | Arrawarra Beach Holiday Park/Spot X Mojosurf Camp

a: 46 Arrawarra Beach Road, Arrawarra, NSW p: (02) 6649 2753  
Van Deal: \$20 per van + \$20 off all surf and stay packages when staying in van  
Accom Deal: None

### 11. SYDNEY DEPOT |

a: 1/1545 Botany Rd Botany Sydney, NSW p: 1300 132 469

### SYDNEY | Base Backpackers

a: 477 Kent St, Sydney NSW, 2000 p: (02) 9267 7718  
No parking but 20% off Accom options when booked direct on  
[www.stayatbase.com](http://www.stayatbase.com) Promo code: Spacemate

### 12. MELBOURNE DEPOT |

a: 42 Macaulay St, Williamstown North, VIC p: 1300 132 469



## Camping in Australia

We highly recommend you use [certified campgrounds](#), whether private owned campgrounds or camping spots offered in Australia's National Parks. Australia is a massive country with lots of wide open space, the rules and regulations for free camping can differ with every council.

Local councils can and will issue fines to people camping for free in non-designated places. It may be a cheap option for a night but that one night could cost you \$200 in a fine or more!



## Spaceships Camping App

Make sure to download the [free Spaceships app](#). Then you'll have all info about where to camp for free and also where to find cheap campgrounds. Our app contains all the info you need on your road trip, including info about local deals, Wi-Fi hotspots, road warnings and petrol stations.

The Spaceships smartphone app is free for all travellers. It's [available for Android and Apple](#). It shows a wide variety of campsites, including the ones where it's legal and free to camp. It is worth having a good look at this and do some planning.

We strongly recommend that you spend a bit of time planning your trip and use one of the many great camping ground options available as much as you can.



## Cost of campgrounds

Australian campgrounds range from \$5 per night to around \$35 per night based on the services and facilities available. They are often in great locations and provide all the services and facilities you need.

Plus, you also get to meet other like-minded travellers, exchange travel stories and get good information from travellers who have experienced products all over the country. There are also hostels and budget motels and hotels located throughout Australia.

### Free guidebook with campground info

Your Spaceship comes with a free copy of the Camps Australia Wide guidebook. This guidebook contains heaps of information about all the main holiday park and campgrounds in Australia. Look for the sites with no \$ sign to find the free sites.

## Camping in Australia: leave no trace!

Please look after Australia during your travels. Leave no trace when (free) camping:

- Plan Ahead and Prepare
- Travel and Camp on Durable Surfaces
- Dispose of Waste Properly
- Leave What You Find
- Minimise Campfire Impacts
- Respect Wildlife
- Be Considerate of Your Hosts and Other Visitors

More information about the 7 principles of camping in Australia [can be found here](#).

Have fun out there exploring Australia. There's heaps to do and see. If you require further information about free camping or on what to see and do, [talk to the friendly Spaceships crew](#). We have a wealth of information on the best operators and activity providers around Australia.



## Vehicle Information

We have put together this video to show you everything about how your Beta Spaceship works. Take your time to check it out if you are unsure how anything functions in your Spaceship:



## Maintaining your Spaceship

It is important to check the following every week:

- Oil level
- Water level (coolant)
- Tyres

**If any warning lights come on the dashboard stop driving immediately and contact Spaceships – 1300 132 469**

The temperature gauge should sit in a horizontal position – if the temperature increases, stop driving immediately. If you do not, the engine can sustain major damage which you could be liable for.

## Opening the Bonnet

1. The lever to open the bonnet is situated below right of the steering wheel.
2. Pull the lever, which will make an opening noise as the bonnet opens to the first stage.
3. From the outside of the vehicle, move around to the front of the bonnet and find the release catch. Pull this catch to release and raise the bonnet.
4. Hold the bonnet in place with the stay.

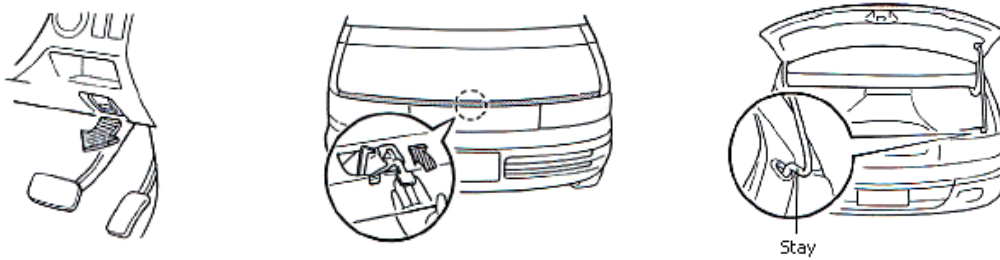

## Engine overview

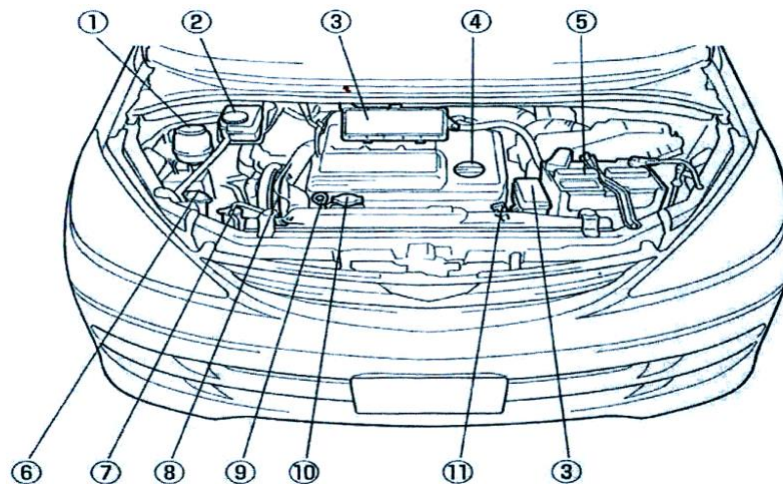

1. Power Steering Fluid Tank
2. Brake Fluid Reserve Tank \*
3. Fuse Box
4. Engine Oil Inlet
5. Battery
6. Washer Tank (windscreen wipers) \*
7. Coolant Reserve Tank
8. V-Ribbed Belt
9. Engine Oil Level gauge \*
10. Radiator Cap
11. Automatic Trans axle Fluid gauge

\*Indicates parts that need routine checks along your journey.

### Checking Oil Level

1. Lift the yellow lever (located at No.9). This will pull out the oil level gauge
2. Wipe all old oil off the gauge.
3. Put back into the hole and wait for a couple of seconds
4. Remove gauge again and check the level at the markers at the end of the tip. This should be at "Full" or just below. Top up oil if it goes under half. Failing to do so can incur costs of repair.

**REMEMBER: This should be done when the engine is cold. Spare oil can be found at the rear**

### Checking Coolant

1. At the front left of the engine you will find the water reservoir tank (located at No. 7)
2. The coolant level always needs to be on the full level on the tank. If this varies please contact us immediately. Do not keep filling this tank without talking to Spaceships.
3. This level should not go below the low level if it does contact Spaceships immediately
4. Failure to report coolant issues voids your insurance.

**REMEMBER: This should be done when the engine is cold**

1. Failure to report coolant issues voids your insurance.



## Checking Tyres

The tyre pressure on the tyres should be 40psi. The tread depth needs a minimum of 1.5mm – to help gauge this, tyres have wear indicator bars moulded across the tread at regular spacing around the tyres.

**If tyres are nearly worn please contact Spaceships – 1300 132 469**

## Changing a Tyre

The jack and tool bag are located at the rear of the vehicle on the left hand side.

The spare tyre is under the back of the Spaceship

1. Park your Spaceship safely (on the firmest, flattest ground you can find).
2. Put a couple of bricks or stones behind the tyres, to make sure the car does not roll off the jack.
3. Make sure the engine is turned off, the gear lever is in parked position and handbrake is on.
4. To retrieve the spare wheel, open the boot and roll up the back of the carpet between the back of the bed and the back door.
5. Loosen the connection bolt in the jack handle bar extender, using the hole of the jack handle.
6. Fit the jack handle to the jack handle bar extender.
7. Loosen the bolt securing the spare tyre with the jack handle and jack handle bar extender.
8. Lift the holding wire slightly and remove it from the hook.
9. The tyre should drop down.

**Take care not to drop it on your foot!**

10. Bring your jack, spare wheel and wheel nut wrench to the work area
11. Loosen the nuts on the car (do this before jacking up the car to prevent the wheel from spinning) by turning anti-clockwise until they are almost off.
12. Place the jack on the ground and extend it manually until the jack enters the groove.
13. Insert the jack handle bar into the hold of the jack handle.
14. Use the jack handle to raise the wheel slightly off the ground
15. Remove the flat tyre
16. Put the spare wheel on then tighten the nuts as much as possible
17. Lower the jack so that the tyre rests on the ground
18. Fully tighten the wheel nuts
19. Replace the hubcap or the plate
20. Voila! You are ready to drive again.

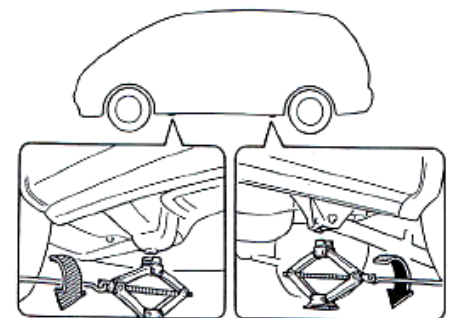
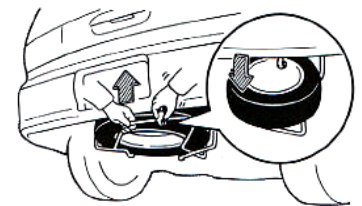
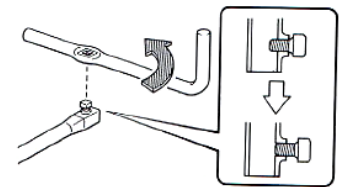
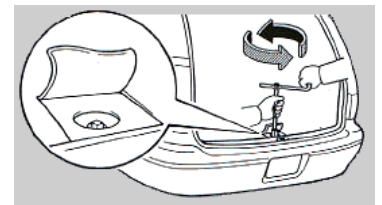
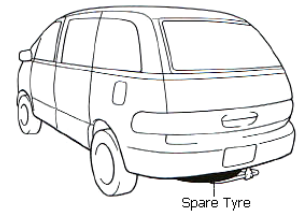

**The spare tyre is a temporary use tyre and is only intended as an emergency replacement to get the vehicle to a place of repair. The maximum allowable speed of the vehicle when one is fitted is limited to 80km/h**

# Operating your Spaceship

## Understanding Automatic Transmission

Driving your Spaceship is easy! It is slightly different to most automatics as the lever to shift into gear is found on the left side of the steering wheel. Press and hold button on lever and pull down.

**P**

**P = Park:** The transmission should be placed in this position when parked and starting or turning off the engine. Keys can be removed from the ignition only when the lever is in this position.

**R**

**R = Reverse**

**N**

**N = Neutral:** The vehicle may be started in this gear, however its main use is for when the vehicle is stationary with the engine in idle mode.

**D**

**D = Drive:** This gear should be used for standard driving. It will automatically change gears for you.

**2**

**2 = Second:** Use as a stronger engine brake for travelling up/down steep hills.

**L**

**L = Low:** This is the strongest engine brake. Used for very steep hills etc. However, care should be taken not to go too fast in this gear. Its purpose is for low speed power and heavy engine braking.

## How to Tilt the Steering Wheel

Make sure your steering wheel is at a comfortable height. The lever is found behind the steering wheel. Move it up to adjust the height. Return the lever to its original position to lock the steering wheel in place.

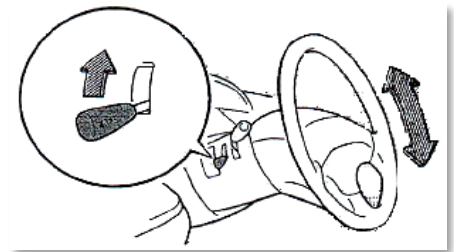



## Warning Lights

Always make sure you are aware of any warning lights that may come on the dashboard. Below is a list of what they are. Please ensure you speak to us immediately if they come on.



O/D  
OFF

### Overdrive Switch

Your spaceship has an overdrive switch found at the end of the gear lever. Overdrive engages a high-ratio 4th gear (overdrive gear) increasing fuel consumption and engine noise.

**It is recommended to use the overdrive function most of the time while driving.**

This means not having the button depressed so the “O/D OFF” light is not showing. If you drive your whole journey with this light on you can damage the transmission or engine. Fees will apply.

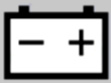

### Battery Warning Light

This light shows when there is a problem with the battery charging system. If this light appears whilst driving it may indicate a broken belt or alternator failure. Stop the vehicle in a safe place and **contact the Spaceships office – 1300 132 469**



### Oil Pressure Warning Light

If this light appears (except when starting the vehicle), the oil pressure is low. Pull over to a safe place and **contact the Spaceships office – 1300 132 469.**

**This indicator is not an indicator for low oil level**



OIL  
LEVEL

### Oil level Warning Light

This light will show if the engine oil level is low. Check the engine oil level immediately.



### Exhaust Temperature Warning Light

This light will appear on ignition but will turn off after a few seconds. If this warning light shows together with the Battery Warning Light, the temperature of the catalytic converter has risen above normal. Park the vehicle in a safe place where there are no materials that may catch fire, such as dry grass or dead plants, and stop the engine for 10 minutes. If the light goes out after restarting the engine, it is safe to drive.

**Should the light remain on or appear again, call the Spaceships office – 1300 132 469.**



### Engine Warning Light

If this light appears, there is a fault within the vehicle's electrical system, or the engine itself.

**Contact the Spaceships office immediately – 1300 132 469.**



### Brake Warning Light

This light will appear under the following conditions.

- When the hand brake is on.
- When the brake fluid is low.
- The hand brake can be found on the right side of drivers seat near the fuel lever.

If this light does not go out when the hand brake is released, stop the vehicle in a safe place and contact the Spaceships office. If an abnormal metallic sound is heard while driving, the brake disc pad may be worn.

**Call the Spaceships office – 1300 132 469**

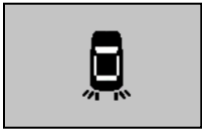

### Blown Light Warning Light

This light will show when a bulb of the tail light or brake light is blown.

- If this light shows when the light switch is ON, a tail light bulb is blown.
- If this light shows when the brake pedal is depressed, a brake light bulb is blown

## How to jump start a Spaceship

All vans are provided with Jumper cables. These can be found in the rear of your van on the left-hand side.

- Start engine of donor car
- Connect one red clamp to POSTIVE + terminal of dead battery and the other red clamp to positive + terminal of the booster battery.
- Connect one black clamp to negative – terminal of dead battery and the other black clamp to negative terminal of booster battery.
- Turn ignition of the car with dead battery and start the engine, simply remove the black clamp (negative cable) from booster battery, remove red clamps.

## How to Open the Fuel Lid

The fuel lid opening lever is found to the right side of the driver's seat on the floor.

**IMPORTANT: Use only unleaded petrol.**

**Do not use E10, this causes damage to the o2 sensors.**

The fuel tank capacity is 60 litres, this will give you around 400 - 450kms per tank.

## Bed Set Up

One of the major benefits of travelling in a Spaceships is the two options for setting up your bed. You can extend the bed internally which is great for colder nights or the recommended option is to extend the bed externally and use the rear awning! The external set up provides excellent ventilation for warmer Australian nights!

### Internal Set Up

#### Rotate the Back Seat

1. Pull the 'recliner adjust lever' on the right side of the rear seat and fold the back of the seat forward.
2. To rotate, turn the seat in an anti clockwise direction.
3. When you have the seat facing backwards, fold back the back of the seat.

**CAUTION: the back seat must be facing forwards whilst driving. Take care of your fingers when rotating the seat!**

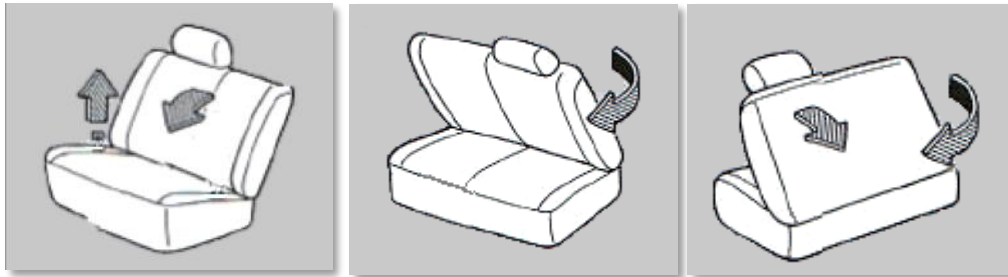

### How to Extend the Bed Internally

1. Swivel the back seat around to face the boot door.
2. Pull out both extendable bed legs on each side of bed.
3. Place wooden board & cushion on top to extend mattress.

**TIP:** To avoid your extension slipping off during the night once you have extended your bed push the back seat as close as you can to the board to stop it slipping.

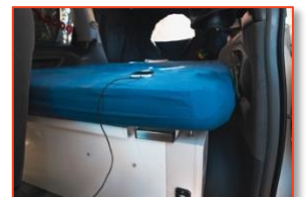

## For extending the bed at the rear:

1. Open the car boot. Here you will find two extendable bed legs..
2. Take the two legs and pull outwards to extend the bed.
3. Once extended, place the wooden board on top to create the base.
4. Put the cushion onto the top to extend the mattress.

## How to Put up the Back Awning

**Please note these covers are for airflow – if heavy rain is expected we recommend using the internal set up.**

1. Open the boot and remove the awning bag. Take out the awning and find the window in the middle.
2. With the hooks at the bottom, wrap the top of the awning over the entire rear door. Make sure it covers the spoiler at the top.
3. At each side you will find two hooks. Attach these each side in the eyelets under the vehicle, just behind the rear wheels
4. You will find another two hooks beneath the awning window. Hook these under the car just behind the bumper next to the spare tyre.



**TIP:** For easy access to make the bed, unzip the window before starting. This way you will be able to reach through the window and pull the bed frame out with ease.

**Please note it is not recommended to use in wet conditions as you may get wet**



## How to Use the Cooker

Your Spaceship comes with two single ring cookers. These take an internal butane canister (these are required to meet local regulations for carrying gas bottles).

You will be given two canisters at the start of your hire. These are free of charge and do not need to be replaced. If more gas is required you can buy more from many outlets such as supermarkets, campgrounds, hardware shops (Bunnings), department shops (Big W, Kmart) and camping shops.



Make sure you set the cooker on a stable surface **outside** the vehicle.

- The cookers are in their own holder which is in the kitchen compartment of the storage area underneath the bed.
- Fit a canister to each cooker.
- Read Instructions on the Gas Cooker before use.

### Where to cook:

#### Rear bed Extension

- Open the boot (tailgate) and cook on the wooden bed extension

#### External Table

- Experience what Australia has to offer – there are picnic tables and other sheltered spots perfect for an outdoor kitchen!

**Never use cookers near the vehicle in any other way. Always put the cookers in their correct carry tray for travelling (please take the gas canister out after use/ while driving).**

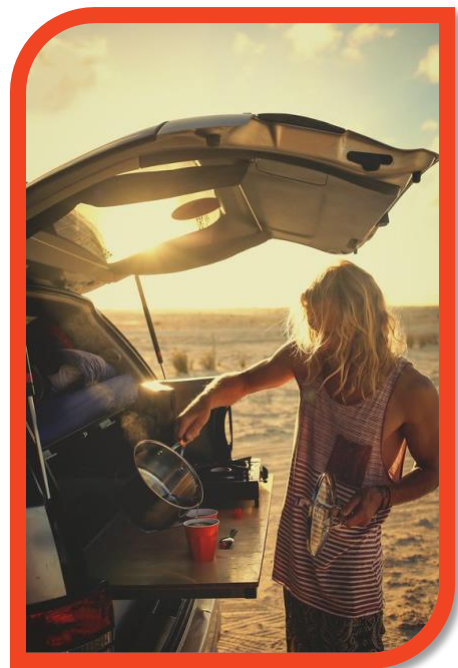

## Understanding the Electrical System

It is important to understand how the electrical system works in your Spaceship so you get the best use out of it. Your Spaceship is fitted with a Smart Battery system.

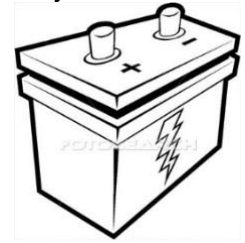

### Smart Battery System

This system is a specially designed power system that powers both the vehicle functions and the internal electrics in the van.

This includes the stereo, USB ports, cabin light above bed on passenger side and fridge. If the battery runs low, it will automatically disconnect from these devices. Always leaving enough charge to start the vehicle.

#### **The battery is charged as the vehicle drives.**

When fully charged, the battery will power the fridge for approx. 15 hours. If all appliances are running it will last around 10 hours.

The van needs to be driven 4-5 hours with no appliances on to give the battery a decent charge.

**TIP:** To save the life on your battery, turn the fridge off at night. The fridge is well insulated and can stay cool until the morning. Remember, you can always use the fridge and freezers at camp site kitchens.

### Cabin Light

On the roof on the left-hand side there is a touch sensitive light. Press this finger print indentation and your light will turn on. Press it again and it will turn off.

**Do not use the other lights in the van for too long as these lights draw power from the battery without going through the smart battery isolator system and can flatten your battery. This may mean you will not be able to start the vehicle.**

## Essential Road Trip Apps

### Spaceships Camping App



Make sure to download the [free Spaceships app](#). Then you'll have all info about where to camp for free and also where to find cheap campgrounds. Our app contains all the info you need on your road trip, including info about local deals, Wi-Fi hotspots, road warnings and petrol stations.

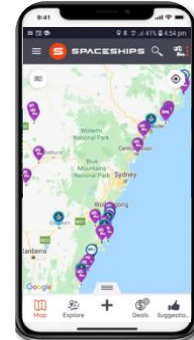

### Spotify Music App



You can't go on a Road Trip without good tunes! Great to download playlists for when you travel out of coverage. We have put together our very own [Spaceships playlist](#) to get in the Space mood!



### Travello



A social Network for Travellers! The ultimate way to meet up with other likeminded travellers. Also get great deals along your journey!





### Fuel Map Australia

This fuel App is a great App to find the lowest petrol prices in the local area. Everyone likes to get a great deal!!

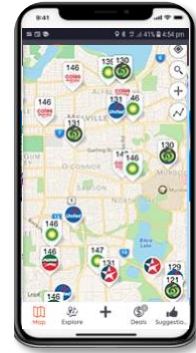

### Skyview

Travelling in a Spaceship – Use this App to spot other Spaceships, Stars, Constellations and all other things you may find in the night Sky!!



### Wi-Fi Map

Access free Wi-Fi anywhere in the country. Even download offline maps for when you are travelling!



### Toilet Map

Don't be caught out again!! The free official National Public Toilet Map app from the Australian Government Department of Health shows the location of more than

19,000 publicly available toilets in Australia and includes details of accessibility, opening hours.





**Have a Safe Journey!**  
**&**  
**Thanks for choosing to travel with**



**You are now officially part a Spaceships Cosmonaut.**

If you want to travel again with us here in Australia, in New Zealand or the UK/Europe you can receive a 10% discount with us!

**Don't forget to share your journey with us @ [#spaceshipsroadtrip](#)**

